

STORM 

TECHNICAL SERVICES FOR
EVENTS, THEATRE, MUSIC,
EXHIBITION, FILM & TV

01483 757211

HIRE@STORMLTD.CO.UK

WWW.STORMLTD.CO.UK

Betapack 2 and Betapack 2 Plus

The Zero 88 Betapack 2 and Betapack 2 *Plus* range of dimmer packs are 4U high professional six channel power controllers capable of driving up to 10 Amps of lighting loads per channel. Channel protection via breakers or fuses. Lighting loads may be resistive or inductive and include tungsten, transformer driven low voltage (eg. pinspots), and quartz halogen. Some highly inductive loads such as neon may require the preheat setting to be adjusted to give smooth control.

Front Panel Controls

Tamperproof Plate (DMX versions only)

Each Betapack 2 with DMX is supplied fitted with a tamperproof plate to prevent unauthorised users from changing the controls. The plate covers the front panel controls but allows all the LEDs to be clearly seen. Remove the centre screw at the top of the plate to access the controls.

Channel Test Switches (Not Betapack 2 Plus)

Each channel has a push on/push off test switch. The 'on' level for all channels is set by the test level preset which is above and to the right of the test switches. A small screwdriver is required to adjust this control.

Green Channel Output Lights

These are next to the channel test switches and give an approximate indication of channel output level. They also show the drive to the triac control elements is working correctly.

Channel Preheat

Each pair of channels has a preheat adjustment. These are located next to the Channel Output Lights. They are used to set the minimum output level of both channels when the output of any controller connected is set to zero. A small screwdriver is required to adjust these controls.

Fuse Blown Neons

Where fitted these are next to each channel fuse and will glow if the fuse is blown.

Plus / Minus Desk Supply

The LED indicator shows the polarity of the supply voltage on pin 7 of the analogue DIN connector. Red is +20v, Green is -20v. Check compatibility with the desk before connecting. To change the polarity setting, move the switch adjacent to the 8pin DIN socket.

Note: If pin 7 of the signal connector of several packs are joined together, all power leds will come on when power is supplied to any of the packs.

Using Betapack 2 Plus with remote inputs

When using a remote control input, ensure that all the faders on the pack are at 0. Mixing local and remote control will result in the highest signal taking precedence.



Owners Information

DMX Address Switches

These set the DMX Start Address and are located next to the XLR 5 DMX connectors. A small screwdriver or trim tool is required to adjust the address settings.

Fade / Hold Switch

This sets how the pack will behave if the DMX signal is lost.

When set to HOLD the last DMX data received will be stored and output until either the DMX control signal is restored or the unit is switched off.

When set to FADE the unit will fade all outputs to zero after one second. This allows the use of an analogue control desk as a backup control system. In either position the control inputs are mixed on a highest takes precedence basis.

DMX 'OK' and 'Error' LEDs

These are located above the DMX Address switches - they show a variety of information:

'OK'	'Error'	
(Green)	(Red)	
ON	OFF	DMX dimmer data (with Start Byte of '00') is being received OK.
ON	ON	DMX data is being received OK, but it is not dimmer data (the Start Byte is not '00')**
OFF	ON	DMX data errors are occurring. This is normally due to transmission speed errors, bad connections, wrong cable, interference or poor or missing line termination. Check the output from the control desk and the connecting cables using a DMX checker such as the test mode of a Zero 88 Linebacker. A terminator plug may be required in the last device on the DMX control line, or the built in termination may be used (see below).
OFF	OFF	No DMX data has been detected.

** When mixed dimmer and other DMX data is being sent together, the DMX 'Error' LED may flash. This is normal.

Installation Details

WARNING

DO NOT REMOVE THE COVER WITHOUT FIRST COMPLETELY DISCONNECTING THE BETAPACK 2 FROM THE MAINS SUPPLY

Removing the Covers

Disconnect the Betapack at the supply.

The mains supply connections and the channel output terminals (Betapack 2 hardwired version only) are under the top cover.

Remove the four screws ('A' in Diagram 6) from the end plates to remove the cover.

The DMX links and the triacs are under the bottom cover. Remove four screws ('B' in Diagram 6) from the end plates to remove the cover.

Connecting the Mains

**A separate isolator and secure mains earth are required.
Phase to Neutral voltage must not exceed 255v.**

Betapack 2s are supplied wired for single phase operation. Cut outs are provided on the ends and rear for PG21 glands; one is supplied.

Single Phase

Betapack 2s are supplied from the factory with two busbars wired for single phase as in Diagram 2. If the busbar for linking Live 1 to Live 2 to Live 3 is not available, use 10mm² cable instead.

Three Phase 'Star'

Remove the single phase busbar (if fitted) from across the three phase input terminals Live 1, Live 2 & Live 3. Ensure that the neutral busbar is in place as shown in diagram 3 opposite.

Wire the supply to Live 1, Live 2, Live 3 and Neutral using at least 2.5 mm² cable.

Three Phase 'Delta'

Using suitable cable (4 to 6mm²) connect the supply terminals together as shown in Diagram 4 opposite. Wire the supply to Live 1, Live 2 and Live 3 using at least 4.0 mm² cable.

Mains Supply Wiring

Always ensure that the *lockwashers* supplied are used. Use an M5 ring tag securely crimped to the mains supply wire if possible.

Otherwise ensure that the mains supply wires are connected as shown in Diagram 7 and that the screws are securely tightened.

Ventilation

When one or more Betapack 2s and/or Betapack 2 Plusses are mounted in an enclosed rack, a fan MUST be fitted to ensure that adequate cool air is circulated.

Up to three Betapack 2s / Betapack 2 Pluses may be stacked in free air.

Mounting

In a 19" Rack

The Betapack 2 is supplied with side brackets fitted for rack mounting.

On a wall

Undo the four screws 'X' to remove the brackets, replace the screws in the holes for future use.

Stand the Betapack 2 on one end. Remove the two screws 'Y' (see Diagram 6), fit the brackets as shown and replace screws 'Y'. Fit the other bracket on the other end.

The wall drilling positions are shown in Diagram 8.

WARNING Completely fit one bracket at a time.

Removal of all four screws 'Y' at the same time can allow the heatsink assembly to fall out!

Allow a minimum vertical spacing of 130mm between packs and between packs and other equipment.

A spacing of 180mm is recommended for ease of wiring and servicing.

For Portable Use

An 'Easicarry' Option Kit consisting of a handle and four feet is available (Stock No: 00-540-00). Contact your dealer for further details.

To fit, remove the brackets. Fit the handle using the screws supplied and holes 'Z'. Fit the four feet to the other end using the holes 'X' and 'Y'. See Diagram 6.

DMX Options (where fitted)

Remove the bottom cover to access these links as described above.

DMX Control Law

As supplied the Betapack 2 DMX output provides a linear law control. If a 'S' law is required (eg when the Betapack 2 is part of a system which has mixed analogue and DMX control), add a short wire link between 'LIN' and '0v' on the DMX Printed Circuit. (See Diagram 5).

DMX Termination

Each Betapack 2 has a built in DMX termination. It is connected by adding a short wire link between 'EOL' and 'DMX-' on the DMX Printed Circuit. (See Diagram 5).

Connection 'CHS' refers to chassis and is unused.

Permanent Installation

Where Betapack 2s are permanently installed it is possible to connect the DMX control cabling to the dimmer internally. The terminals marked 'DMX+', 'DMX -' and 'OV' should be used (see Diagram 5).

BETAPACK 2 REAR VIEW WITH THE PANEL REMOVED

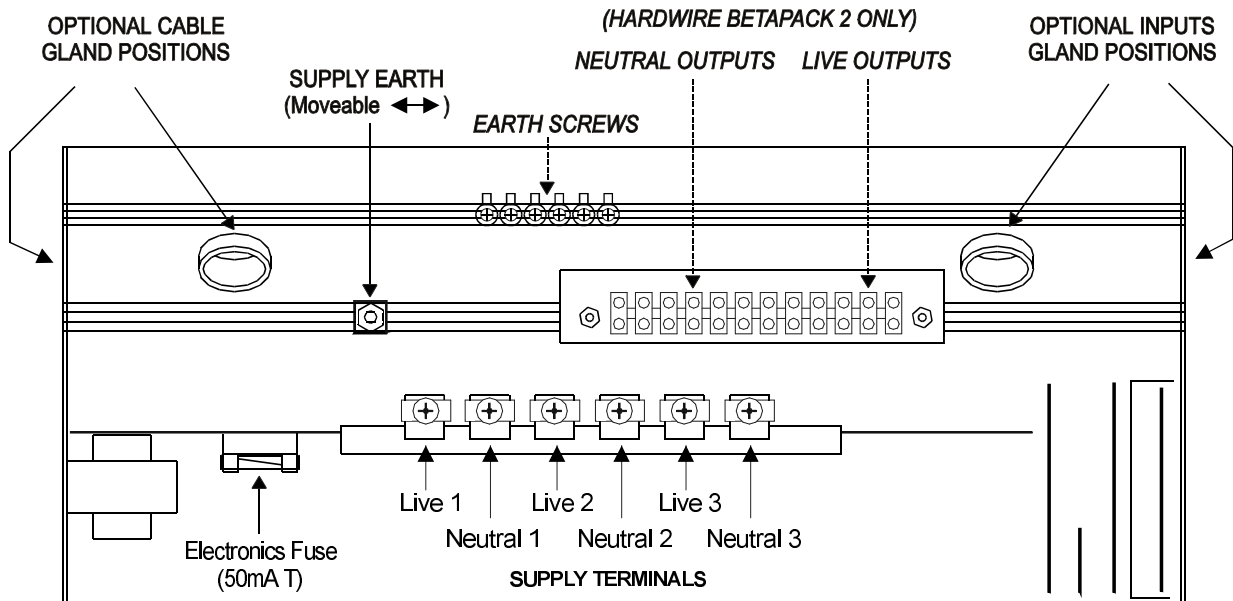
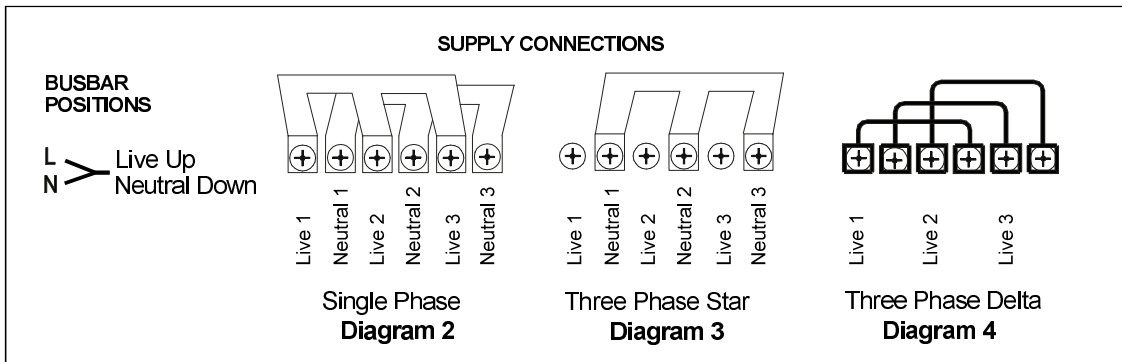

Diagram 1



SUPPLY CONNECTIONS

BUSBAR POSITIONS

L Live Up
N Neutral Down

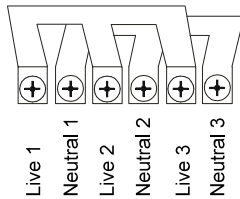

Single Phase
Diagram 2

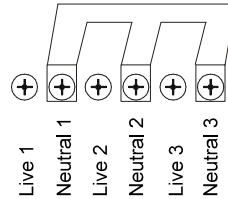

Three Phase Star
Diagram 3

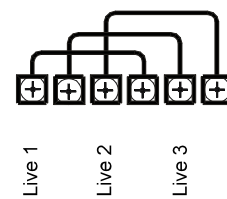

Three Phase Delta
Diagram 4

View of DMX Connections Block

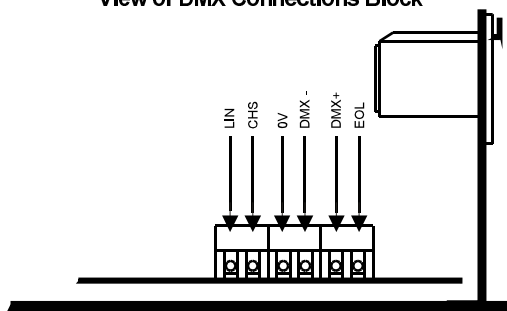

Diagram 5

End Plate - Bracket shown in Wall Mounting Position

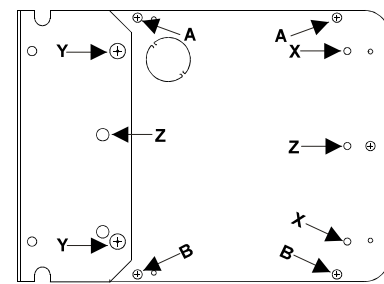

Diagram 6

Supply Terminal

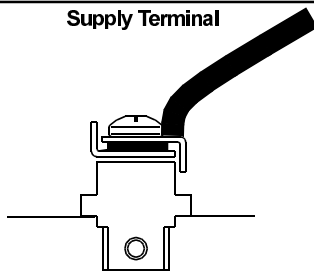

Diagram 7

Wall Drilling Diagram

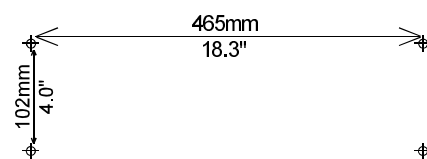

Diagram 8

Technical Specification

Electrical

The Betapack 2 range is designed to operate on 230v + 10 % - 15% ac supplies at 50Hz. The packs will not operate satisfactorily outside these specifications.

The packs may be wired:

Single Phase: 60A 1 phase 2 wire 230v (255v max phase to neutral).

Earth leakage less than 1mA.

Three Phase Star: 20A 4 230/380v (255v max phase to phase).wire

Earth leakage less than 1mA.

Three Phase Delta: 30A 3 wire 230v. (255 max phase to phase).

Earth leakage less than 4mA.

Max total load: 13.9kW @ 230v.

Load per channel: 0.1A Min; 10A Max

No load consumption: 10w

If used in conjunction with MCBs, to avoid nuisance tripping use high inrush current (Type K) MCBs .

Input Signals: 0 to + 10v or 0 to -10v, autosensing.

Desk Supply is +/- 20v nominal at 100 mA.

Polarity is set by a switch on the front panel.

Input Impedance: not less than 50kW

Physical

Max Operating Temperature: 40° C Ambient

Size: Free Standing: 447 x 177 x 195mm (17.5 x 7 x 7.7 inches)

Rack Mounted: 483 x 177 x 195mm (19 x 7 x 7.7 inches)

Wall Mounted: 483 x 177 x 240mm (19 x 7 x 9.5 inches).

Net Weight: 8 kg (17.6lbs).

DMX - XLR 5 (on the front panel)

Pin 1	0v
2	Data -
3	Data +
4	Not connected
5	Not connected

Portable Appliance Testing

WARNING The Betapack 2 will fail the portable appliance high voltage test as it has capacitors connected between Live 1 and Earth and between Neutral and Earth to enable it to comply with CE regulations.

Fusing

Channel Outputs

11/4" Fuses

Where appropriate ONLY use 11/4" x 1/4" (32 x 6.3mm) 10A rapid (F) HRC ceramic fuses (Zero 88 Part No 40-110-00).

DO NOT USE Ultra rapid (FF) or time delay (T) (Anti Surge) fuses.

Cartridge Fuses

Cartridge type fuseholders use 10.3mm x 38mm 10A HRC Ceramic fuses (Zero 88 Part No 40-120-00).

Neutral Disconnect

Breakers and Cartridge fuse versions isolate the live and neutral when tripped or open.

Fusing of Inductive Loads

All inductive loads (eg. pinspots, any transformer driven lamp) must be fitted with a separate fuse of the correct value per lamp or fitting.

Failure to fit the correct fuse may mean that any supply disturbances could destroy the lamp transformer.

For a single pinspot, a 500 mA Quick Blow or 250mA AntiSurge fuse should be used.

Analogue - 8 pin DIN (on the front panel)

Pin 1	Channel 1
2	2
3	3
4	4
5	5
6	6
7	Supply Voltage
8	0 volts Reference



Manual Stock Number: 7367000

Third Issue - October 1998.

Zero 88 Lighting Ltd reserves the right to make changes to the equipment described in this manual without prior notice.

This equipment is designed for professional stage lighting control, and is unsuitable for any other purpose.

It should be used by, or under the supervision of, an appropriately qualified or trained person.

E&OE. Zero 88 reserves the right to change the specification without prior notice.

Zero 88 Lighting Ltd, Usk House, Llantarnam Park, Cwmbarn, Gwent NP44 3HD, U.K.

Tel: +44 (0)1633 838088 (24hr Answerphone) Fax: +44 (0)1633 867880

email: sales@zero88.com.

www.zero88.com.